

VBOX Touch

RLVBTOUCH-V2



The VBOX Touch features a 25 Hz GNSS receiver, responsive colour touchscreen and the ability to run multiple applications on the same hardware. Built on a platform that allows functionality to be expanded through future software and firmware upgrades, the VBOX Touch is an extremely versatile data logger.

Applications are written in Python script enabling users to create their own, including custom CAN Based applications to solve specific testing needs. New applications can be loaded by inserting an SD card containing the new script and it is just as quick to revert to the standard functionality of the VBOX Touch, by inserting the SD card containing the original data.

Other features include the ability to connect to a vehicle's CAN Bus, capture screenshots and see live test results.

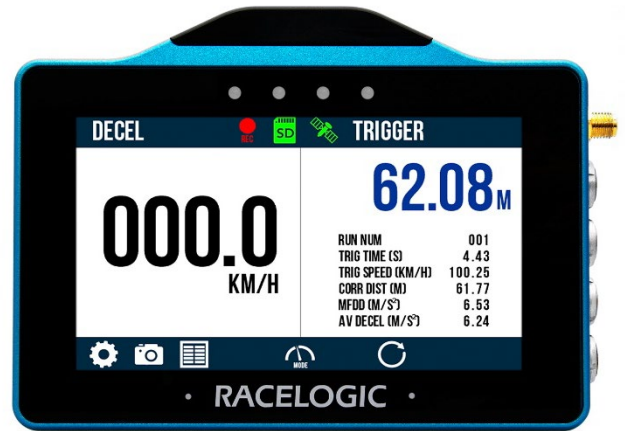

Features

- 4.3" TFT daylight readable capacitive touch screen
- 4 x high brightness LED indicators
- Wi-Fi connectivity
- 25 Hz GNSS receiver with internal patch antenna
- Python-based applications; ideal for solving user-specific testing needs
- Log up to 64 CAN channels across two CAN Bus interfaces
- Removable protective rubber cover included
- SMA connector for external GNSS antenna (overrides the internal antenna when connected)

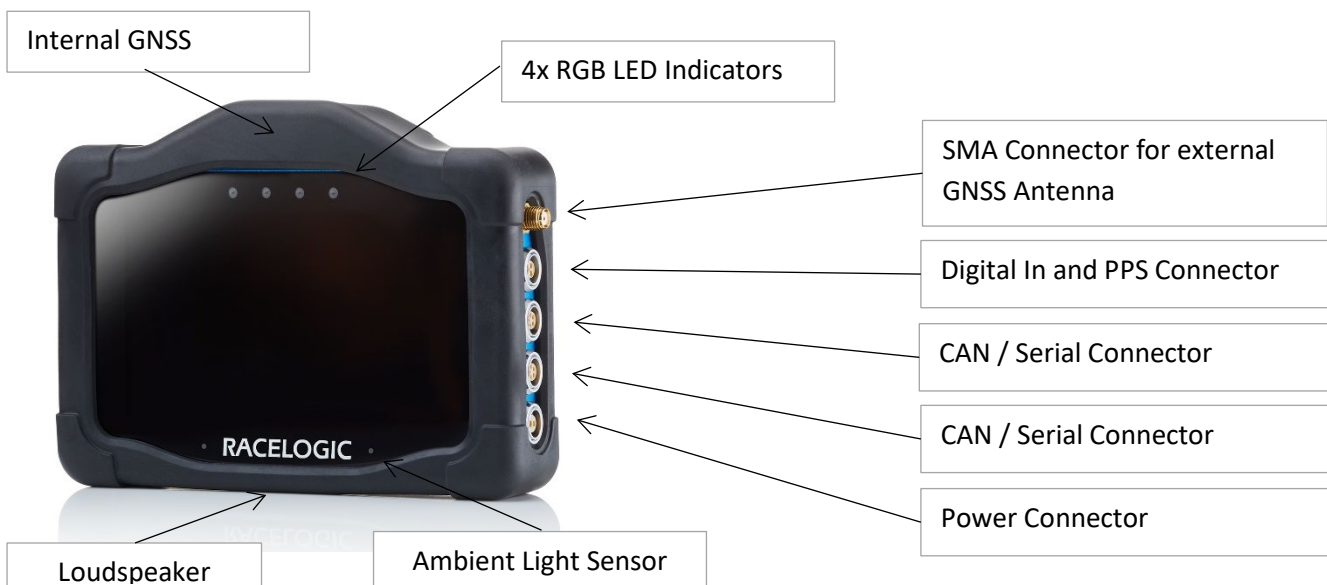

VBOX Touch

RLVBTOUCH-V2



GNSS Specifications

Velocity		Distance	
Accuracy	0.1 km/h (averaged over 4 samples)	Accuracy	0.05 % (< 50 cm per km)
Update rate	25 Hz	Resolution	1 cm
Maximum velocity	1600 km/h		
Minimum velocity	0.5 km/h		
Resolution	0.01 km/h		

Position		Acceleration	
Accuracy Standalone*	H: 2 m	Accuracy	1 %
Accuracy with SBAS*	H: 1.3 m	Maximum	4 g
Resolution	0.00185 m	Resolution	0.01 g

Heading		Trigger Brake Stops	
Resolution	0.01°	Accuracy	±10 cm
Accuracy	0.3°		

* Specifications will vary depending on the number of satellites used, obstructions, satellite geometry (PDOP), multipath effects, and atmospheric conditions. For maximum system accuracy, always follow best practices for GNSS data collection.

Supported GNSS Signals

GPS	GLONASS	Galileo	BeiDou
L1C/A (1575.42 MHz)	L1OF (1602 MHz + k* 562.5 kHz, k = -7,..., 5, 6)	E1-B/C (1575.42 MHz)	B1I (1561.098 MHz)

VBOX Touch

RLVBTOUCH-V2



Connector Pin Allocation

SMA Connector 1

GNSS Antenna Connector:			
Pin	I/O	Function	
Centre	I	RF Signal / Power for active antenna	
Shell	I	Ground	

5-way LEMO Connector 1

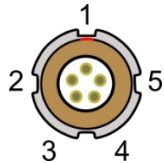
CAN/ Serial Connector:			
Pin	I/O	Function	
1	O	Tx-RS232	
2	I	Rx-RS232	
3	I/O	CAN High	
4	I/O	CAN Low	
5	I	Power	
Shell	I	Ground	

5-way LEMO Connector 2

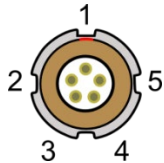
CAN/ Serial Connector:			
Pin	I/O	Function	
1	O	Tx-RS232	
2	I	Rx-RS232	
3	I/O	CAN High	
4	I/O	CAN Low	
5	I	Power	
Shell	I	Ground	

3-way LEMO Connector

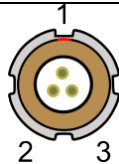
Digital In and PPS Connector:			
PIN	I/O	Function	
1	I	Ground	
2	O	PPS	
3	I	Event/Brake Trigger	

2-way LEMO Connector

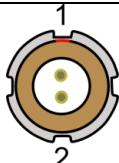
Pin	I/O	Function	
1	I	Power	
2	I	Ground	
Shell	I	Ground	

VBOX Touch

RLVBT TOUCH-V2



Environmental and Physical

Environmental and Physical	
Input Voltage	6 – 30 V DC
Power	< 7W, powered using the supplied cigar plug with 2 m cable
Operating Temperature	-20°C to +60°C
Storage Temperature	-20°C to +80°C
Size (rounded)	
Unit	138 x 96 x 29 mm
Rubber Cover	142 x 103 x 36 mm
Weight	
Unit	375 g
Rubber Cover	75 g

Touch Screen	
Size	4.3" TFT Capacitive Touch
Resolution	480*800 pixels
TFT LCD Display Colours	262K colours (18 Bit)

Mounting	
Richter mounting system or ¼" 20TPI UNC	

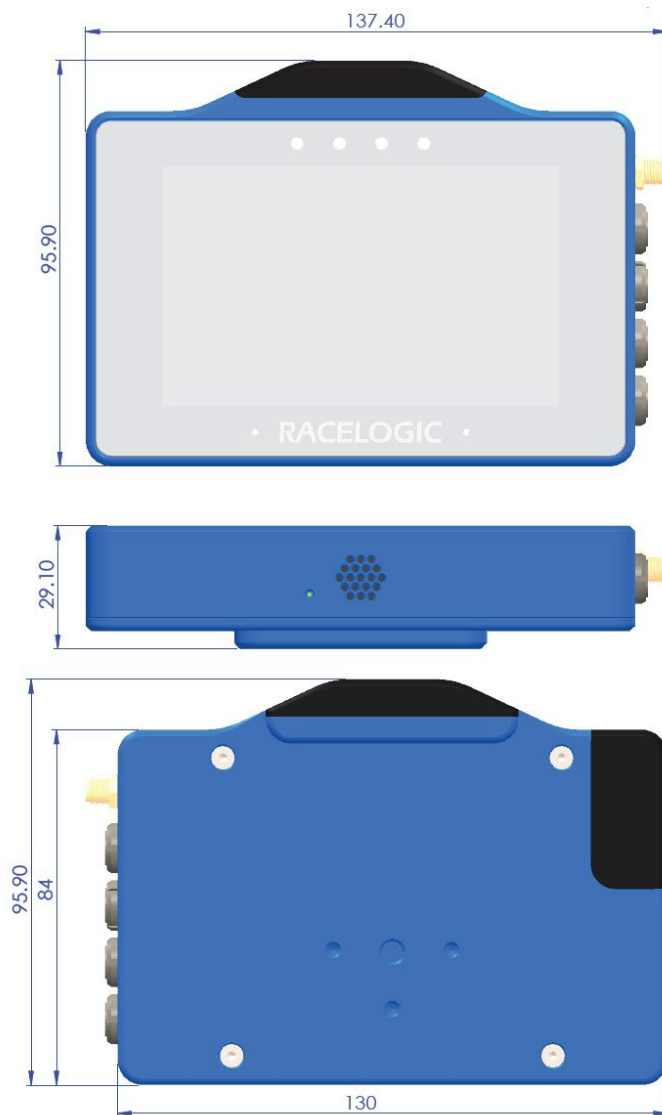

Package Contents

Description	Product Code
1x VBOX Touch Unit including Rubber Cover	VBTOUCH-V2
1x Cigar Plug Power Supply Cable (2 m)	RLCAB010LE
1x 8 GB SD Ultima Pro UHS-1 Memory Card	RLACS313
1x GNSS antenna	RLACS262
1x Windscreen Suction Mount	RLACS331
1x Plastic Carry Case for VBOX Touch	RLACS281
1 x Calibration Certificate	RLCALUKAS