

# VBOX Touch RTK

RLVBTOUCHR



VBOX Touch RTK is a data logger with a 4.3" colour touchscreen that offers robust speed and positional data. Featuring a 10 Hz, RTK enabled GNSS receiver, it can track the GPS, Galileo, GLONASS and BeiDou satellite constellations as well as receive RTK correctional signals from either a fixed Base station or NTRIP modem.

VBOX Touch RTK is capable of tracking three satellite constellations at any one time, with GPS and Galileo being tracked at all times, giving the user a choice of whether to track GLONASS or BeiDou as the third constellation.

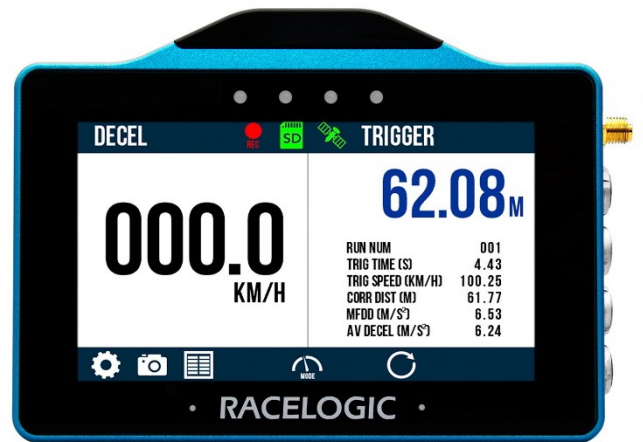

VBOX Touch comes pre-installed with a versatile Performance app for acceleration and deceleration testing. More apps can be downloaded from the [VBOX Automotive website](#) and loaded onto the unit using the supplied SD card. All apps are written in Python script and users can write their own, including custom CAN Based applications, to solve specific testing needs.

## Key Features

- Centimetre-level position accuracy
- 10 Hz GNSS receiver (GPS, GLONASS, Galileo & BeiDou)
- Receives RTK correctional signals
- Write your own Python-based apps
- 4.3" TFT daylight readable capacitive touch screen
- Log up to 64 CAN channels across two CAN Bus interfaces
- Brake trigger input support
- Free library of applications available to download and install via an SD card
- 4 x high brightness LED indicators

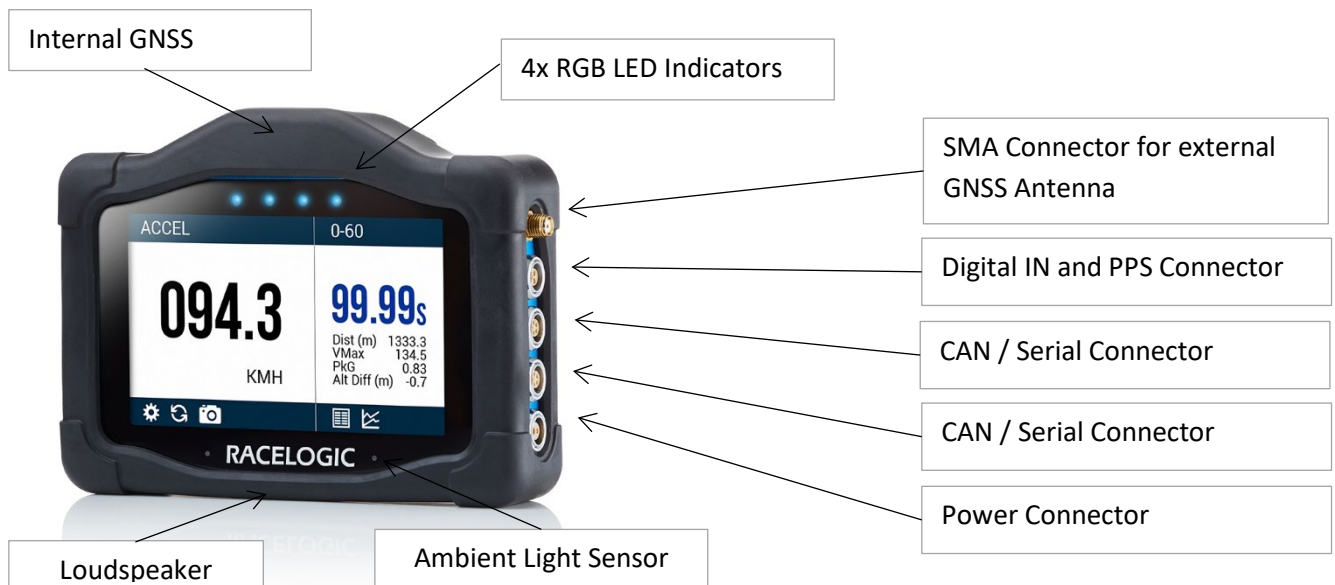

# VBOX Touch RTK

RLVBTOUCHR



## GNSS Specifications

Velocity		Distance	
Accuracy	0.1 km/h (averaged over 4 samples)	Accuracy	0.05 % (< 50 cm per km)
Update rate	10 Hz	Resolution	1 cm
Maximum velocity	1,600 km/h	Update rate	10 Hz
Minimum velocity	0.5 km/h		
Resolution	0.01 km/h		

Position		Acceleration	
Accuracy (Standalone)*	H: 1.5 m CEP	Accuracy	1 %
Accuracy (with SBAS)*	H: 1.0 m CEP	Maximum	4 g
Accuracy (with RTK)*	H: 0.01 m + 1 ppm CEP V: 0.01 m + 1 ppm R50	Update rate	10 Hz
Update rate	10 Hz	Resolution	0.01 g
Resolution	0.00185 m		

Heading		Trigger Brake Stops	
Resolution	0.01°	Accuracy	±5 cm
Accuracy	0.3°		
Update rate	10 Hz		

\* Specifications will vary depending on the number of satellites used, obstructions, satellite geometry (PDOP), multipath effects, and atmospheric conditions. For maximum system accuracy, always follow best practices for GNSS data collection.

1 ppm means 1 mm/km away from base. ppm is limited to baselines up to 20 km

## Supported GNSS Signals

GPS	GLONASS	Galileo	BeiDou
L1C/A (1575.420 MHz)	L1OF (1602 MHz + k* 562.5 kHz, k = -7,..., 5, 6)	E1-B/C (1575.420 MHz)	B1I (1561.098 MHz)
L2C (1227.600 MHz)	L2OF (1246 MHz + k* 437.5 kHz, k = -7,..., 5, 6)	E5B (1207.140 MHz)	B2I (1207.140 MHz)

# VBOX Touch RTK

RLVBTOUCHR



## Connector Pin Allocation

### SMA Connector 1

GNSS Antenna Connector:		
Pin	I/O	Function
Centre	I	RF Signal / Power for active antenna
Shell	I	Ground



### 5-way LEMO Connector 1

CAN/ Serial Connector:		
Pin	I/O	Function
1	O	Tx-RS232
2	I	Rx-RS232
3	I/O	CAN High
4	I/O	CAN Low
5	I	Power
Shell	I	Ground

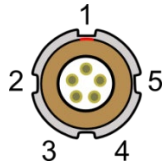

### 5-way LEMO Connector 2

CAN/ Serial Connector:		
Pin	I/O	Function
1	O	Tx-RS232
2	I	Rx-RS232
3	I/O	CAN High
4	I/O	CAN Low
5	I	Power
Shell	I	Ground

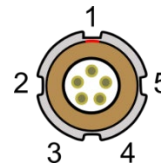

### 3-way LEMO Connector

Digital In and PPS Connector:		
PIN	I/O	Function
1	I	Ground
2	O	PPS
3	I	Event/Brake Trigger



### 2-way LEMO Connector

Pin	I/O	Function
1	I	Power
2	I	Ground
Shell	I	Ground

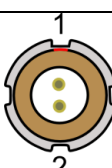

# VBOX Touch RTK

RLVBTOUCHR



## Environmental and Physical

Environmental and Physical	
<b>Input Voltage</b>	6 – 30 V DC
<b>Power</b>	<7 W
<b>Operating Temperature</b>	-20°C to +60°C
<b>Storage Temperature</b>	-20°C to +80°C
<b>Size (rounded)</b>	
Unit	138 x 96 x 29 mm
Rubber Cover	142 x 103 x 36 mm
<b>Weight</b>	
Unit	375 g
Rubber Cover	75 g

Touch Screen	
<b>Size</b>	4.3" TFT Capacitive Touch
<b>Resolution</b>	480*800 pixels
<b>TFT LCD Display Colours</b>	262K colours (18 Bit)

Mounting	
Richter mounting system or ¼" 20TPI UNC	



## Package Contents

Description	Product Code
1x VBOX Touch RTK Unit <b>including Rubber Cover</b>	VBTOUCHR-V1
1x Cigar Plug Power Supply Cable (2 m)	RLCAB010LE
1x 8 GB SD Ultima Pro UHS-1 Memory Card	RLACS313
1x GNSS antenna	RLACS308
1x Windscreen Suction Mount	RLACS331
1x Plastic Carry Case for VBOX Touch	RLACS281
1x Calibration Certificate	RLCALUKAS